



**Reifen**Design pur  
////// individuell für Sie





**BRINGEN SIE DAS  
MAXIMUM AN FARBE  
AUF IHREN REIFEN**

## ReifenDesign pur

////// individuell für Sie

**Individueller, größer und exklusiver.**  
Mit einer speziellen High-Tech-Technologie ist es uns möglich noch kreativere Designs und Markenbotschaften auf Ihren Reifen zu bringen. Wir heben das Reifenstyling auf eine neue Ebene. Ob komplett in einer Farbe, verspielte Muster oder einfache Schrift – nichts ist als Aufdruck der Seitenwand Ihres Reifens unmöglich.

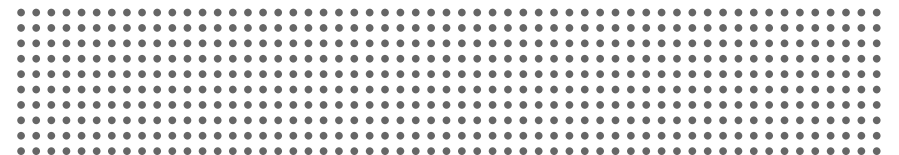

# JEDER REIFENTYP GUT BEDRUCKT



Fahrrad

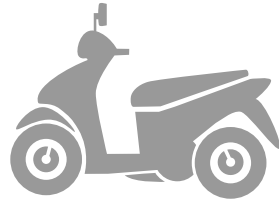

Roller



Motorrad



Quad



Auto



LKW

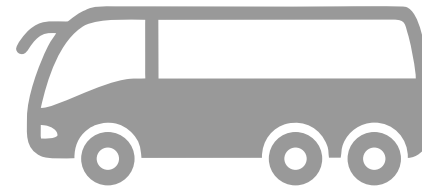

Bus



Kart

# ReifenDesign pur

individuell für Sie

TPIMP



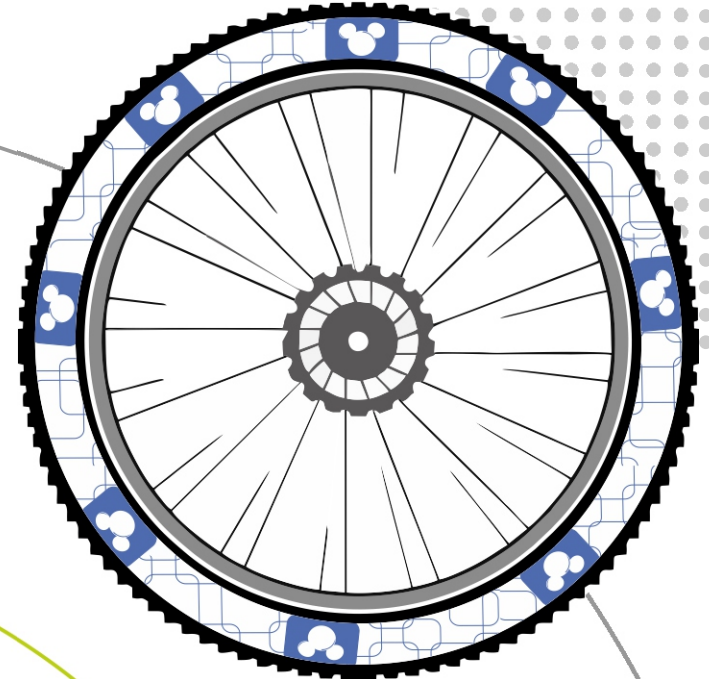
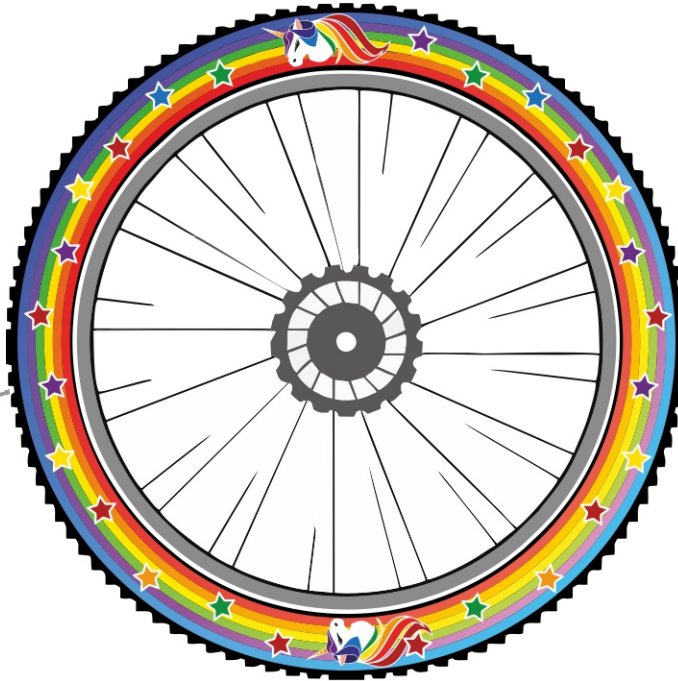
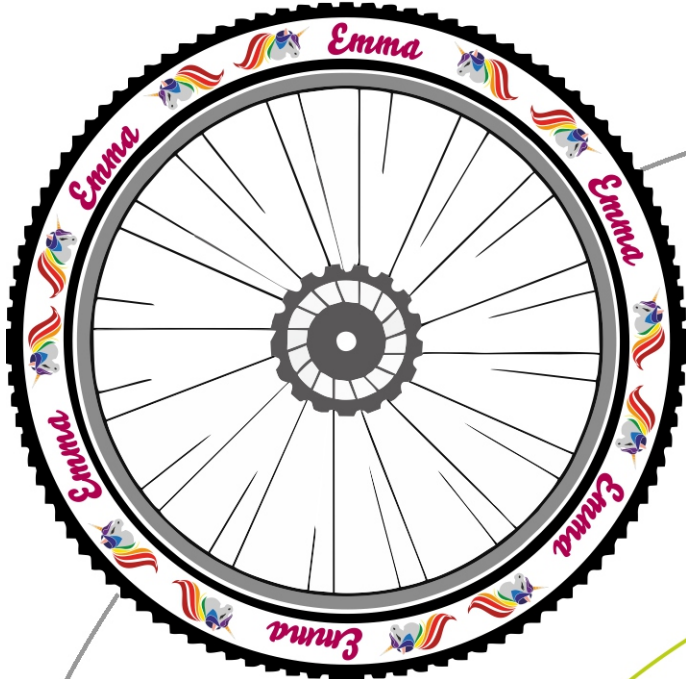

# ReifenDesign pur

/// /// /// /// individuell für Sie



Fahrrad

TPIMP

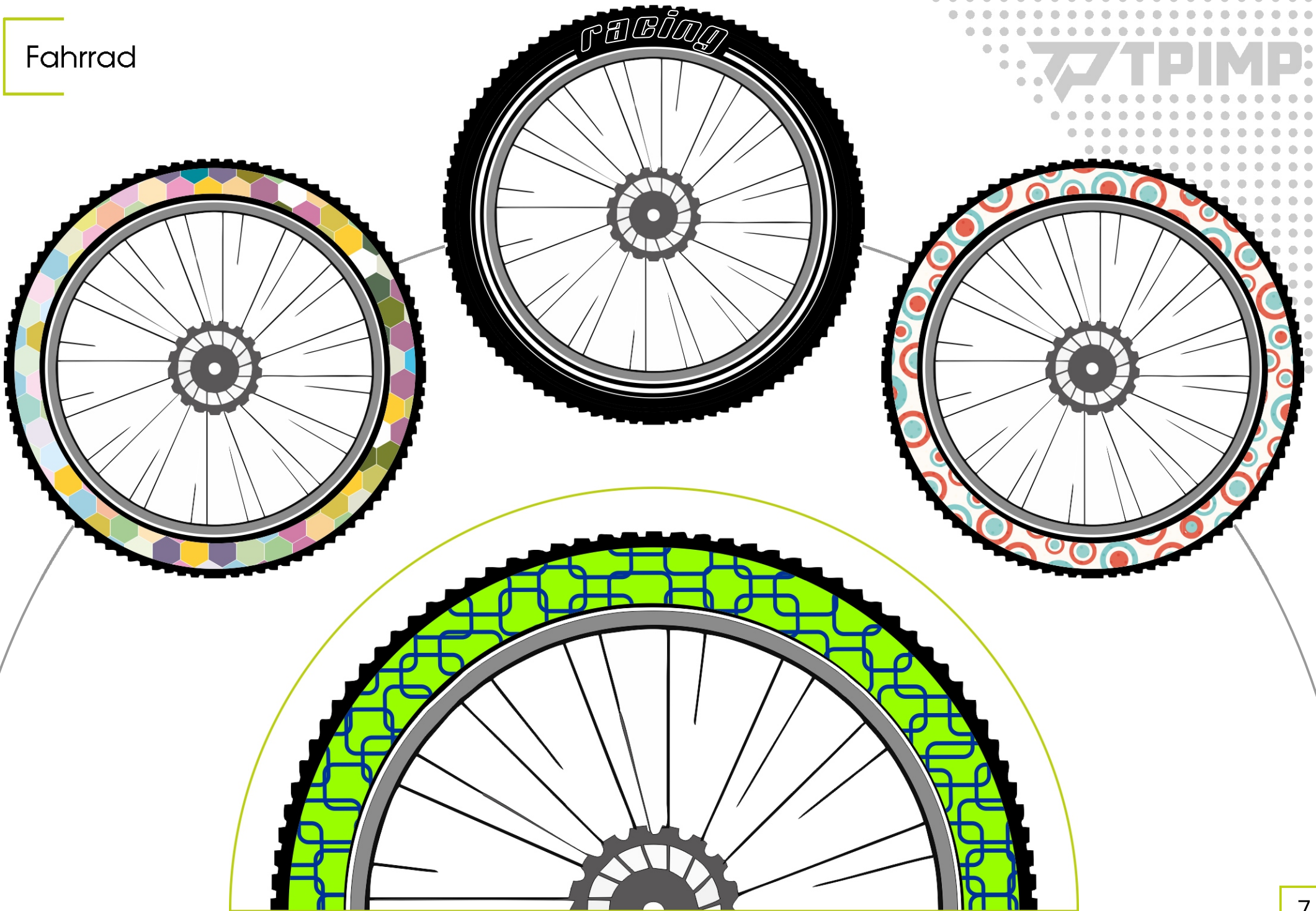

# ReifenDesign pur

/// /// /// /// /// individuell für Sie

TPIMP





Roller

TPIMP



# ReifenDesign pur

/// /// /// /// individuell für Sie

TPIMP



Motorrad

TPIMP



# ReifenDesign pur

/// /// /// /// individuell für Sie

TPIMP



Quad

TPIMP



# ReifenDesign pur

/// /// /// /// /// individuell für Sie

TPIMP



Auto

TPIMP

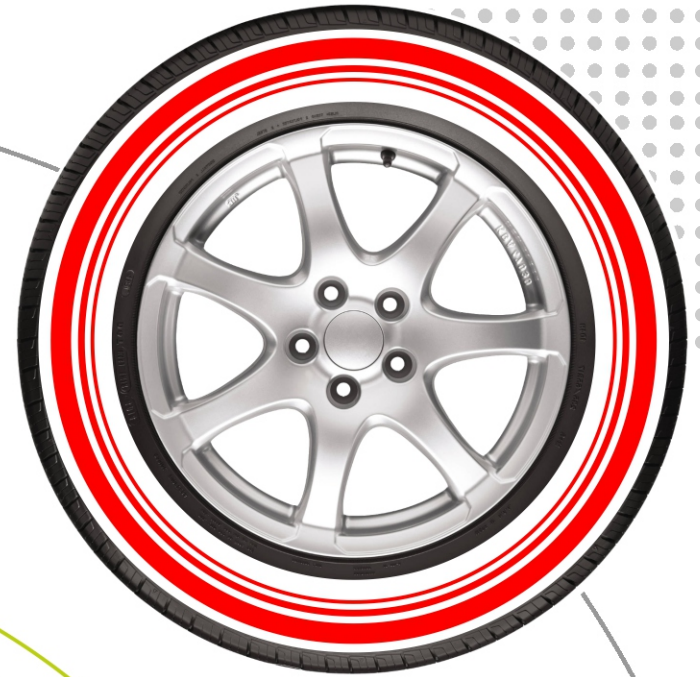

# ReifenDesign pur

/// /// /// /// /// individuell für Sie

TPIMP





Auto

TPIMP



# ReifenDesign pur

/// /// /// /// individuell für Sie

TPIMP



Auto

TPIMP



# ReifenDesign pur

/// /// /// /// /// individuell für Sie

TPIMP



LKW

TPIMP

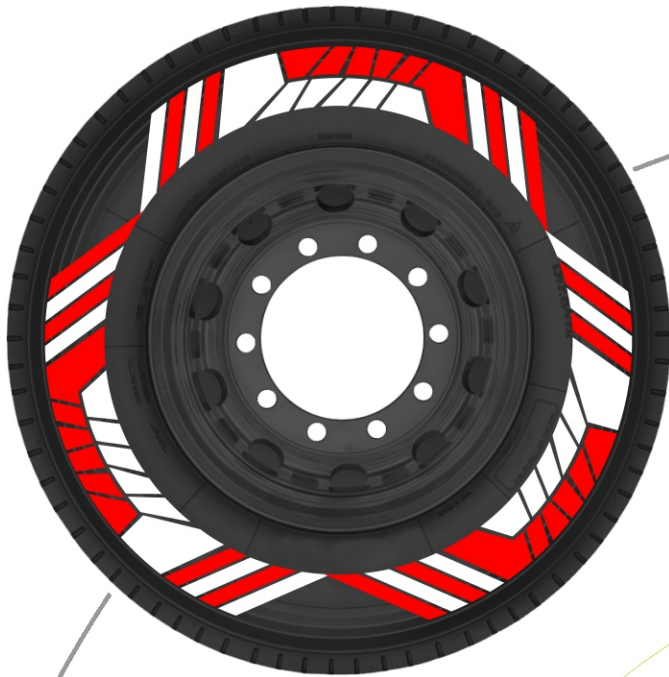

# ReifenDesign pur

individuell für Sie

TPIMP



Bus

TPIMP

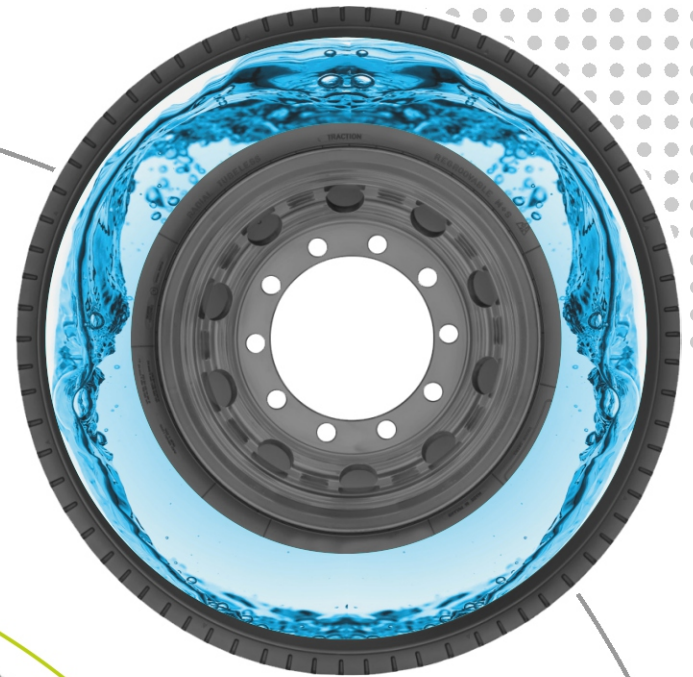

# ReifenDesign pur

////// individuell für Sie

TPIMP





Kart

TPIMP



# ReifenDesign pur

/// /// /// /// individuell für Sie

Autofans, Hobby-Bastler oder Profi-Tuner setzen mit der individuellen Reifengestaltung ihren Geschmack bis ins letzte Detail um und hinterlassen in der Tuning-Szene bleibenden Eindruck. Eine Beschriftung ist selbstverständlich **in Kombination mit und ohne Felgen möglich.**

Auf der anderen Seite sehen die Veredelungen nicht nur richtig gut aus, sondern lassen sich parallel auch wunderbar **als Werbefläche nutzen.** Ob Reifenhersteller, Autohersteller, Händler, Sponsor oder anderes Unternehmen – jeder erhält mit dieser Bedruckung in Form des Logos oder Firmennamens die Möglichkeit gesehen oder als Förderer wahrgenommen zu werden.

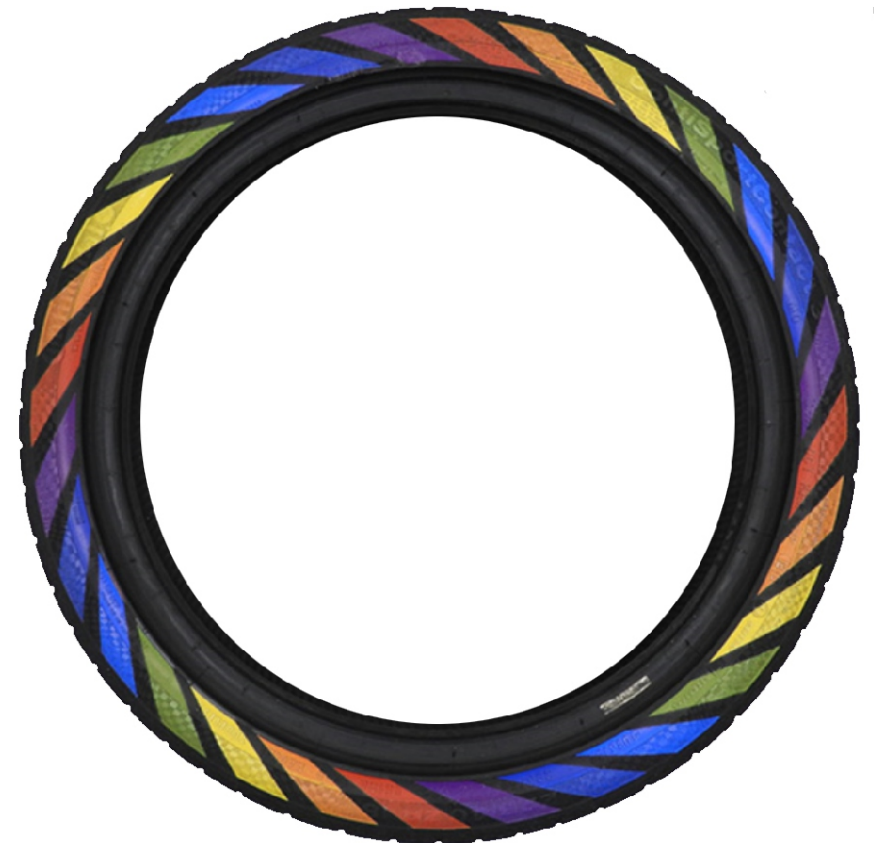

–01  
**REIFENLOGISTIK**



–02  
**DESIGN-  
AUSWAHL**

–03  
**REIFEN-  
VORBEREITUNG**



–04  
**REIFEN-  
BEDRUCKUNG**

–05  
**VERSAND**



## IN NUR 5 SCHRITTEN ZUM SELBST DESIGNTEN REIFEN!

1. Bevor es losgeht, muss der Reifen zu uns! Handelt es sich um neue Reifen, so weisen Sie Ihren Händler einfach darauf hin. Er kümmert sich dann um den Versand der Reifen.
2. In unserem Katalog finden Sie einige Beispiel Designs zur Ansicht. Wählen Sie unter den zahlreichen Vorschlägen Ihren Favoriten oder lassen Sie uns Ihre Idee zukommen – wir erstellen Ihnen gerne ein personalisiertes Angebot.
3. Vor dem Druck muss der Reifen gesäubert werden. Dabei entfernt unser Team alte Beschriftungen, säubert das Material sorgfältig und prüft den Reifen auf Schäden.
4. Nun kommt das Wichtigste: Das individuelle Design wird aufgebracht.
5. Im letzten Schritt macht sich der Reifen auf den Weg zu Ihnen. Dabei können Sie natürlich Ihre Wunschadresse angeben. Wir liefern ihn dann kostenlos an Ihre Adresse, den Reifenhändler oder die Werkstatt



**ReifenDesign pur**  
// // // // // individuell für Sie

